

07.2008 TR80A017 RE

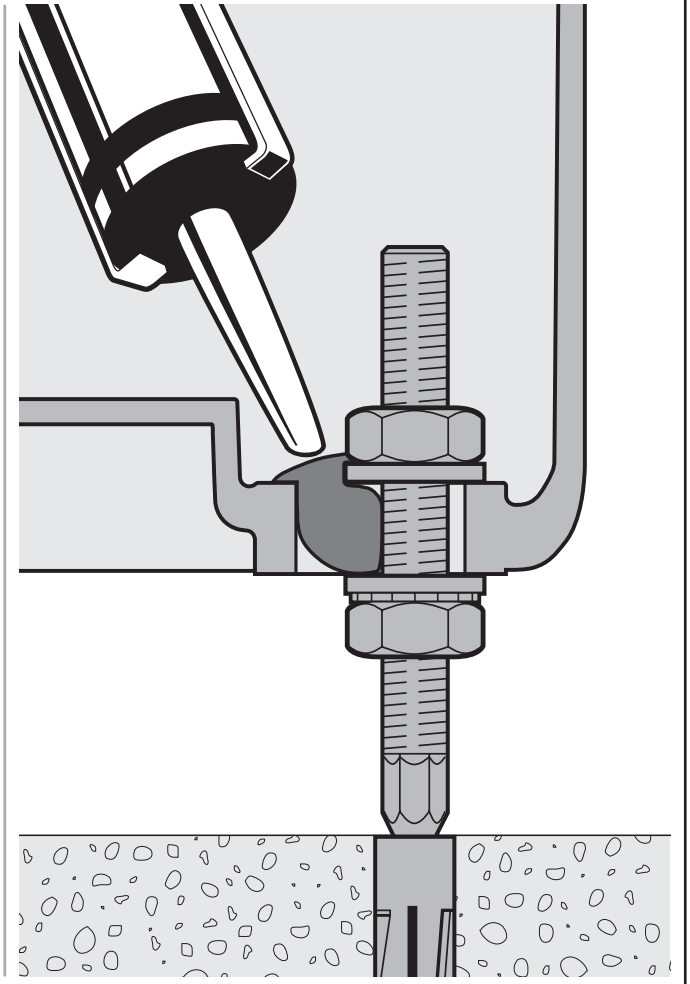

07.2008 TR80A017 RE

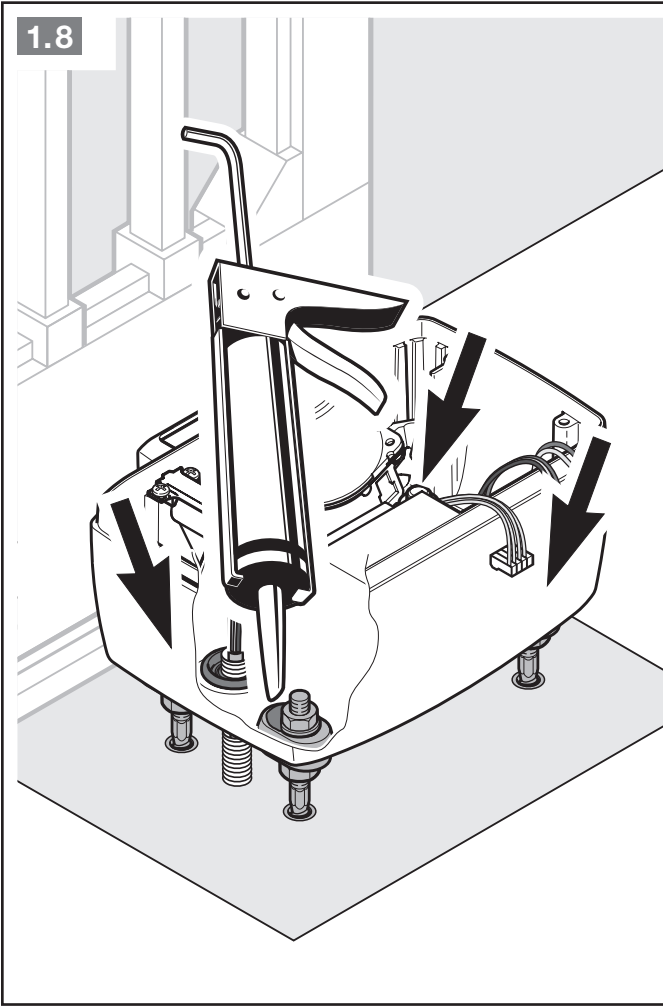